

OPERATING AND MAINTENANCE MANUAL

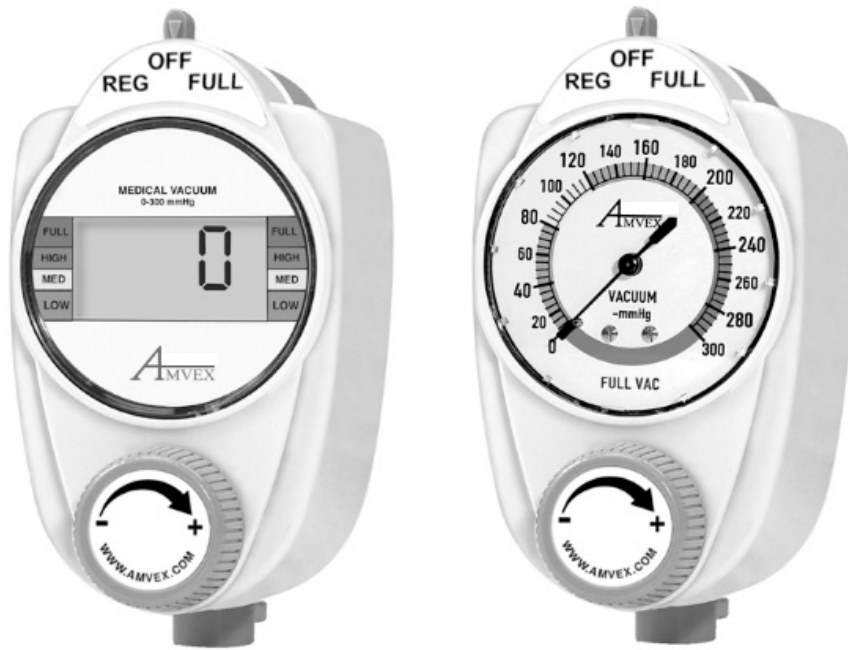

- VACUUM REGULATOR - CONTINUOUS DIGITAL & ANALOG



Rx Only

Vacuum Regulator Type:

Body Colors:

VR - XXYY - XXYZ

Color Code:

Display:

Patient Connection:

Wall Connection:

Basic matrix shown. Consult the Ohio Medical website for full matrix or contact your Ohio Medical representative.

The product package label contains your product identifier and description

CE
0086

CONTINUOUS VACUUM REGULATOR PART IDENTIFICATION

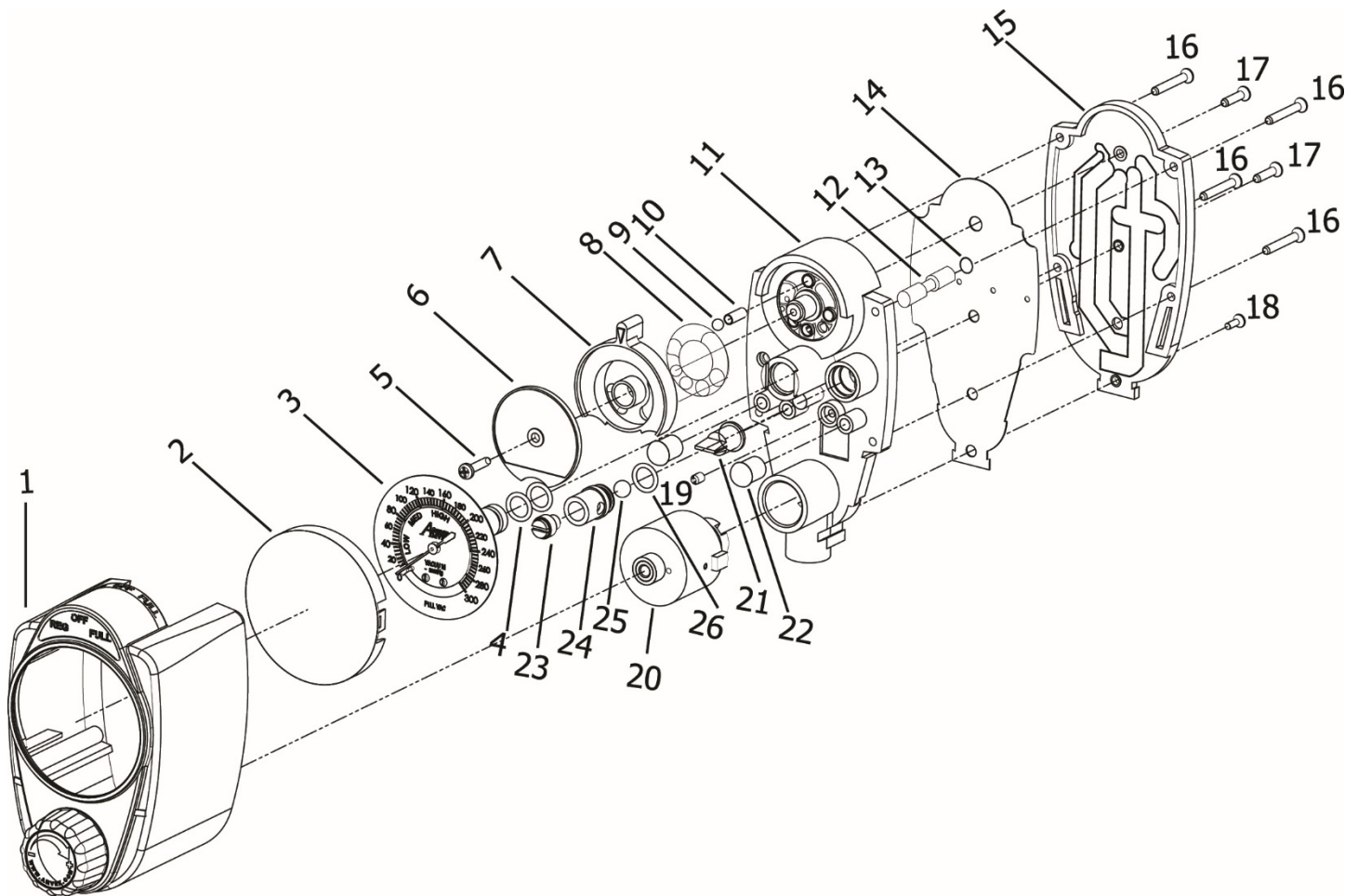







1	Face Assembly (2 mode face assembly, 3 mode face assembly)	14	Back Gasket
2	Analog Lens	15	Back Plate
3	Gauge: 0-100mmHg Gauge (Analog or Digital) 0-160mmHg Gauge (Analog or Digital) 0-200mmHg Gauge (Analog or Digital) 0-300mmHg Gauge (Analog or Digital) 0-760mmHg Gauge (Analog or Digital)	16	Cover Screws (4 pcs)
4	Gauge O-Rings (2 pcs)	17	Back Plate Screws (2 pcs)
5	Selector Screw	18	Bottom Plate Screw
6	Selector Face Plate (2 mode continuous, 3 mode continuous)	19	Orifice
7	Selector Switch	20	Regulating Module (Standard, Pediatric & Neonatal Regulating Module, High Regulating Module)
8	Selector O-Ring	21	Positive Pressure Relief Valve
9	Index Ball	22	Port Cap (2 pcs)
10	Index Spring	23	Pediatric Relief Screw (Pediatric & Neonatal Models Only)
11	Back Body	24	Pediatric Relief Body (Pediatric & Neonatal Models Only)
12	Selector Plug	25	Pediatric Relief Ball (Pediatric & Neonatal Models Only)
13	Selector Plug O-Ring	26	Pediatric Relief O-Ring (Pediatric & Neonatal Models Only)

IMPORTANT: SAFETY INSTRUCTIONS

This manual provides you with important information about the Vacuum Regulators and should be read carefully to ensure the safe and proper use of this product.

Read and understand all the safety and operating instructions contained in this booklet.

If you do not understand these instructions, or have any questions, contact your supervisor, dealer or the manufacturer before attempting to use the apparatus.

WARNING:	Indicates a potentially hazardous situation, which if not avoided, could result in death or serious injury			
ATTENTION:	Indicates a potentially hazardous situation, which if not avoided, could result in minor or moderate injury			
CAUTION:	Indicates a potentially hazardous situation, which if not avoided, could result in damage to the device or other property			
	Symbol indicates the device complies with the requirements of Directive 93/42/EEC concerning medical devices (on CE marked devices only)			
	Consult operating manual		Serial Number	
	Manufacturer	Rx Only	Caution: Federal (USA) Law restricts this device to sale by or on the order of a licensed healthcare provider.	
	Manufacturer's authorized representative in the European Union			
	Catalog Number (Device Identifier). This identifier includes alpha-numeric characters that correspond to the vacuum regulator model, gauge type, color and any fittings ordered. It is located on the outer package label of your unit.			
	The stork symbol indicates low pressure vacuum gauge commonly used for pediatric and neonatal applications			
GAUGE COLORS:	Analog gauges include color coding along the graduation marks as follows:			
	Analog Gauge Color	160mmHg Gauge	300mmHg Gauge	760mmHg Gauge
	Green	0 – 80 mmHg Graduations	0 – 80 mmHg Graduations	N/A
	Yellow	80 – 120 mmHg Graduations	80 – 120 mmHg Graduations	N/A
	Orange	120 – 160 mmHg Graduations	120 – 200 mmHg Graduations	All Graduations
	Red	N/A	200 mmHg - Full Graduations	N/A

RECEIVING INSPECTION

Remove product from package and inspect for damage. If product is damaged, DO NOT USE and contact your dealer or equipment provider.

ATTENTION: It is very important to allow product to remain in original packaging for 12-24 hours to acclimate to room temperature before use.

USER RESPONSIBILITY

WARNING: The procedures described in this service manual should be performed by trained and authorized personnel only. Maintenance should only be undertaken by competent individuals who have a general knowledge of and experience with devices of this nature. Read completely through each step in every procedure before starting this procedure; any exceptions may result in a failure to properly and safely complete the attempted procedure. No repairs should ever be undertaken or attempted by anyone not having such qualifications. Genuine Amvex replacement parts must be used for all repairs. This product performs as explained in this manual as long as the assembly, use, repair and maintenance are properly followed according to our instructions. Elastomers and other components may become worn over period of use. Periodic examination of this device is recommended. If any damage or defects are present, the product should not be used. This includes parts that may have been altered, contaminated, worn or missing. Replacement parts are available as listed on the last page of this manual.

WARNING: Operation of this device is not to be done if flammable, anesthetics are present due to the possibility of explosion caused by static discharge.

MRI WARNING: This product may contain magnetic, ferrous material that may affect the result of an MRI. For MR Conditional options, contact your Ohio Medical Representative at 1.866.549.6446.

INTENDED USE

Amvex Vacuum Regulators are intended to regulate a supplied vacuum pressure to the users desired vacuum level. A gauge shows the value of the regulated vacuum, which is adjustable via a regulating knob.

Vacuum Regulator Model	Gauge Range	Gauge Accuracy	
		Analog	Digital
Continuous	0 - 200 mmHg	+/- 3% F.S.	+/- 1% F.S. at 22°C
	0 - 300 mmHg	+/- 3% F.S.	+/- 1% F.S. at 22°C
Pediatric Continuous	0 - 160 mmHg	+/- 3% F.S.	+/- 1% F.S. at 22°C
Neonatal Continuous	0 - 100 mmHg	+/- 3% F.S.	+/- 1% F.S. at 22°C
High	0 - 170 mmHg	+/- 3% F.S.	+/- 1% F.S. at 22°C

Please note: F.S. = Full Scale

Flow Rates	Standard	Pediatric
Continuous	0 – 80 L/min	0 – 40 L/min

OPERATING INSTRUCTIONS

ATTENTION: The operating and storage temperature for the regulator should reflect typical environmental conditions of a medical facility environment.

WARNING: DO NOT change, alter or modify the intended use of the product.

Other Equipment Needed:



¼" (0.635cm) Suction tubing, Suction filter or overflow safety trap, collection canister.

Equipment Setup:

Depending on the desired location of the regulator, connect the vacuum adapter directly into the wall outlet, or connect one end of an Amvex vacuum hose assembly onto the supply port of the suction regulator and the other end onto the vacuum source (i.e. wall outlet).

Use ¼" suction tubing, between the patient and patient port of the collection canister, as well as between the outlet port of the Vacuum Regulator and canister. A high flow suction filter and/or an overflow safety trap between the regulator and the collection canister should be used to prevent occlusion or contamination of the regulator, wall outlet or pipeline system.

Selecting the Mode:

REG:		Allows degree of vacuum to be adjusted by use of the regulating knob.
OFF:		Vacuum is no longer on or being supplied to patient.
FULL:		Maximum vacuum is administered to patient.

NOTE: REG mode is only available on the 3 mode models

ATTENTION: When selector is set in-between REG and OFF, patient will receive full wall vacuum.

Battery Low Indicator (Digital Models Only):

NOTE: When a battery icon appears on the gauge it indicates that the battery is low. Please take the unit out of service immediately and contact an Ohio Medical Customer Service Representative for battery replacement. If the low battery condition is not addressed and the battery becomes fully depleted, the gauge will not show any readout including the low battery icon or gauge pressure. If the gauge were to go blank during suctioning, the unit will continue to suction and the intermittent feature will continue to operate. Once completing that procedure, it is important to immediately take the unit out of service and contact Ohio Medical Customer Service Representative for battery replacement.

Procedures Prior to Use:

WARNING: The following tests are recommended **prior to use on each patient**. If the Vacuum Regulator does not pass one or more of the following tests, it should be evaluated, repaired and/or replaced by a qualified individual.

The following tests must be done with a minimum supply vacuum of -53 kPa(-400 mmHg):

1. Move the selector switch to the "OFF" position. Turn the regulator knob one complete turn in the clockwise direction. Kink the vacuum tubing to block the outlet. There should be no movement of the gauge needle (or in case of a digital gauge, no change in display).
2. Move the selector switch to the "REG" position. Turn the regulator knob fully in the counter-clockwise direction. Kink the vacuum tubing; again, there should be no movement of the gauge needle (or in case of a digital gauge, no change in display).
3. Kink vacuum tubing.

Regulator Setting:

Standard: Increase the vacuum to -12 kPa (-90 mmHg)

Pediatric & Neonatal: Increase the vacuum to -5 kPa (-40 mmHg)

4. Open and close the kinked vacuum tubing slowly to reach various vacuum rates. Ensure that the level of vacuum maintains consistently when the vacuum tubing is kinked.

Standard Continuous and High Vacuum:

Follow the steps below based on mode type

2 Mode:

5. Decrease the vacuum to zero and move the selector switch to the "OFF" position. |

3 Mode:

5. Move the selector switch to the "FULL" position. Kink the vacuum tubing and ensure that the vacuum gauge is reflecting the maximum suction available.

5b. Move the selector switch to the "REG" position.

5c. Decrease the vacuum to zero and move the selector switch to the "OFF" position. |

Pediatric & Neonatal Continuous:

6. In the "REG" position, kink the vacuum tubing and turn the regulator control knob fully in the clockwise direction to ensure that the vacuum level does not go over -21 kPa (-160 mmHg) for Pediatric and -13 kPa (-100mmHg) for Neonatal.

NOTE: This feature is only present in the Pediatric and Neonatal models.

7. Decrease the vacuum level to zero and move the selector switch to the "OFF" position.

Setup for Patient use:

Setting the Level of Vacuum for Patient use:

1. **Complete Procedures Prior To Use**
2. Move the selector switch to the "REG" position.
3. Kink the vacuum tubing.
4. Set the required vacuum level.

WARNING: The vacuum tubing must be kinked to ensure that the patient is not exposed to a higher level of vacuum than what is required.

5. Move the selector switch to the "OFF" position.
6. Attach the vacuum tubing to the vacuum canister.

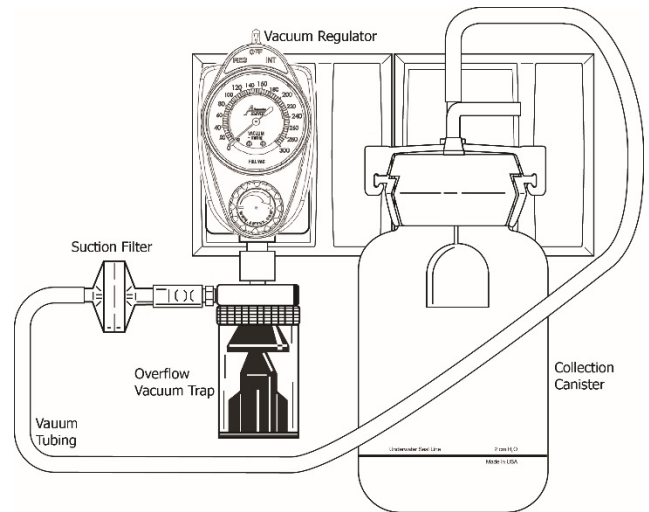

CLEANING INSTRUCTIONS

The following internal cleaning procedure may be followed if your unit becomes contaminated.

1. Connect the supply port of the Vacuum Regulator to the patient port of a collection canister.
2. Attach the vacuum port of the collection canister to a vacuum source.
3. Connect a hose from the patient port of the Regulator to be cleaned and place the other end into a container containing 100cc of a cold sterilant.
4. Fully increase the regulating knob of the vacuum regulator (clockwise).
5. Turn on the Vacuum Regulator to the "REG" mode. Wait until all of the cold sterilant is passed through the regulator.
6. Repeat steps 3,4 & 5 for all modes of the Vacuum Regulator.
7. Repeat steps 3,4 & 5 using 100cc of isopropyl alcohol to purge the Vacuum Regulator of the sterilant.
8. The Regulator should run for 30 sec. in each mode with its patient port open to atmosphere to dry internal parts.

CAUTION: Ethylene oxide is not recommended. Sterilization using an ethylene mixture may cause small surface cracks to some of the plastic parts that may not be apparent to the user.

CAUTION: Do not steam autoclave, immerse in liquid or gas sterilize the Vacuum Regulators. This may damage the unit.

CAUTION: If Vacuum Regulator becomes contaminated internally, warranty is voided. Do not send Vacuum Regulator back to the manufacturer. Follow your facilities procedures for handling contaminated products.

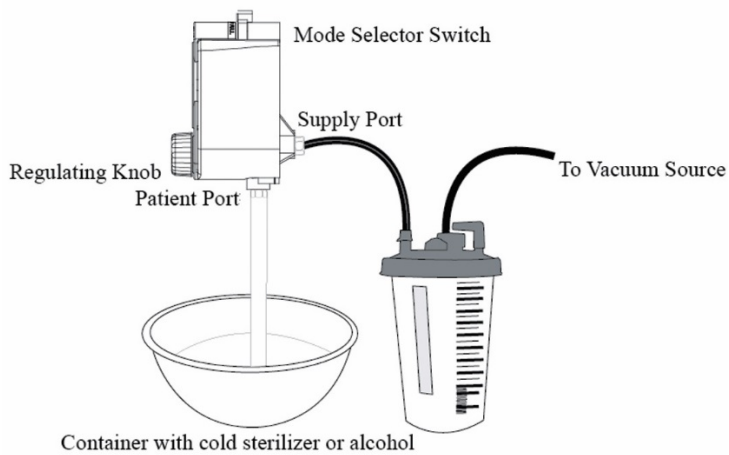

RECOMMENDED MAINTENANCE

The following are recommended maintenance steps that should be taken after each patient:

1. Clean the exterior of the Vacuum Regulator with a solution of a diluted mild detergent.
2. Make sure all secondary apparatus such as canisters and tubing are thoroughly cleaned.
3. Inspect the bacteria filter. If it has been contaminated replace with a new one.
4. Inspect the overflow safety trap to make sure it is free of any restrictions.

REPLACEMENT PARTS

VR-AG-100MM-WL	Analog Gauge with Lens 100mmHg
VR-AG-160MM-WL	Analog Gauge with Lens 160mmHg
VR-AG-200MM-WL	Analog Gauge with Lens 200mmHg
VR-AG-300MM-WL	Analog Gauge with Lens 300mmHg
VR-AG-760MM-WL	Analog Gauge with Lens 760mmHg
VR-DG-100MM	Digital Gauge with Lens 100mmHg
VR-DG-160MM	Digital Gauge with Lens 160mmHg
VR-DG-200MM	Digital Gauge 200mmHg
VR-DG-300MM	Digital Gauge with Lens 300mmHg
VR-DG-760MM	Digital Gauge with Lens 760mmHg
VR-MODULE	Regulating Module Assembly
VR-MODULE-H	Regulating Module Assembly 760mmHg
VR-ORING-KIT-P	1 Set of O-rings, Gaskets and Filters for all Continuous Pediatric & Neonatal Models.
VR-ORING-KIT-C3	1 Set of O-rings, Gaskets and Filters for Continuous Models (C3, C2 & CH)

WARRANTY

This Product is sold by Ohio Medical, LLC., (the "Company") under the express terms of the warranty set forth below. For a period of THIRTY SIX (36) MONTHS (or for a period of ONE HUNDRED AND TWENTY (120) MONTHS in North America ONLY) from the date the Company ships this Product to the customer, but in no event for a period of more than three years from the date of original delivery by the Company to an authorized dealer, this Product, other than its expendable parts (e.g., batteries for Digital Gauge) is warranted to be free from functional defects in materials and workmanship and to conform in all material respects to the description for the Product contained in this operation manual, if this Product is properly operated under conditions of normal use, regular periodic maintenance and service is performed and repairs are made in accordance with this operation manual. The warranty period for all expendable parts of the Product is sixty (60) days from the date the Company ships the Product to the customer. The foregoing warranty shall not apply if the Product has been repaired or altered by anyone other than the Company or an authorized dealer; or if the Product has been subjected to abuse, misuse, negligence, or accident. The Company reserves the right to stop manufacturing any product or change materials, designs, or specifications without notice. This warranty is extended to only the initial customer with respect to the purchase of this Product directly from the Company or an authorized dealer as new merchandise. Dealers are not authorized to alter or amend the warranty of any Product described in this agreement. Any statements, whether written or oral, will not be honored or be made part of the agreement of sale. THIS WARRANTY IS EXPRESSLY IN LIEU OF ANY OTHER WARRANTIES, EXPRESS OR IMPLIED, INCLUDING ANY WARRANTY OF MERCHANTABILITY OR FITNESS FOR A PARTICULAR PURPOSE. THE COMPANY SHALL NOT BE LIABLE FOR INCIDENTAL, COLLATERAL, CONSEQUENTIAL, OR SPECIAL DAMAGES INCLUDING, BUT NOT LIMITED TO, LOST PROFITS, OR LOSS OF USE. THE COMPANY'S LIABILITY, IN THE AGGREGATE, SHALL NOT EXCEED THE PURCHASE PRICE OF THE PRODUCT. In order to file a warranty claim, customer is required to return Product prepaid to the Company at 1111 Lakeside Drive Gurnee, IL 60031 USA. As determined at the sole discretion of the Company, Products which qualify under the warranty will be repaired or replaced, at the Company's option, and returned to customer via ground delivery at the Company's expense. All claims for warranty must first be approved by Ohio Medical Customer Service Department: (customerservice@ohiomedical.com or 866.549.6446). Upon approval the customer service department will issue an RMA number. An RMA must be obtained prior to commencement of any warranty claim.

EC REP

Oxygen Care Ltd.
2 Holfeld Business Park
Kilmacanogue Co Wicklow
Ireland



Ohio Medical LLC
1111 Lakeside Drive
Gurnee, IL 60031 USA
Tel: 1.866.549.6446
www.ohiomedical.com

